

WILLBRANDT Rubber Expansion Joint Type 40

DN 200 - DN 5000



















Type 40 is a high-corrugated, highly elastic rubber expansion joint. Due to its corrugation it has very low inherent resistance. It is characterised by its ability to absorb a large amount of movement in any direction. The type and amount of corrugation, installation length and material strength of this type can all be tailored to your requirements. There are also a large number of rubber qualities available, which means that you can select a suitable rubber compound for any application (see the material descriptions on the following pages).

Type 40 is mainly used in large industrial plants and power plants, where it compensates offsetting and compression, insulates vibration and absorbs pipe movement.



Bellow design	High corrugated rubber bellow with reinforcement and shaped solid rubber flanges, self-sealing (no additional seals required). Suitable for backing flanges with a supporting shoulder.	Accessories	<ul style="list-style-type: none"> - Guide sleeves - Potential equalisation - Flame-resistant protective covers - Dust and splash protection covers - Earth cover / sun protection hoods - Segment tie rods - PTFE lining
Flange version	Both sides with backing flange made of galvanized steel with clearance holes, drilled according to DIN PN 10 (standard). Other materials and dimensions are possible.	Movement absorption	Very large axial, lateral and angular movement absorption possible. Different corrugation geometries and bellow designs (single- and multi-corrugated) available.
Pressure resistance	Design according to customer specification, max 40 bar operating pressure.	Approvals/conformity	Approved for drinking water, FDA and EG 1935/2004 conform
Vacuum resistance	Only vacuum-resistant with a vacuum supporting ring.		

Specifications

Bellow		Bellow design			Max. temperature °C	Permissible operating data							
Colour code	Colour marking	Core (Inner)	Reinforcement	Cover (outer)		°C	bar	°C	bar	°C	bar	°C	bar
red		EPDM	Polyamide	EPDM	100								
blue		EPDM TW	Polyamide	EPDM	100								
white/red		EPDM beige	Polyamide	EPDM	100								
red		EPDM AF	Polyamide	EPDM	100								
green		CSM	Polyamide	CSM	100								
yellow-grey		NBR	Polyamide	CR	100								
white-grey		NBR beige	Polyamide	CR	100								
grey		CR	Polyamide	CR	90								
red-blue-red		EPDM	Aramid	EPDM	100								
blue-blue-blue		EPDM TW	Aramid	EPDM	100								
white-blue-red		EPDM beige	Aramid	EPDM	100								
orange-blue-orange		EPDM HT	Aramid	EPDM HT	125								
red-blue-red		EPDM AF	Aramid	EPDM	100								
green-blue-green		CSM	Aramid	CSM	100								
yellow-blue-grey		NBR	Aramid	CR	100								
white-blue-grey		NBR beige	Aramid	CR	100								
grey-blue-grey		CR	Aramid	CR	90								
lilac-blue-lilac		FPM	Aramid	FPM	180								
-	-	Silicone	Aramid	Silicone	180								
-	-	Silicone	Glass fabric	Silicone	200								

Expansion joints will be designed according to your operating parameters.

WILLBRANDT Rubber Expansion Joint Type 40

Application

Type 40 red (EPDM)

For water, sea water, cooling water with glycol or other chemical additives for treating water, saline solutions, weak acids and weak alkaline solutions. Unsuitable for aliphatic, aromatic and chlorinated hydrocarbons, oil or oily media.

Type 40 blue (EPDM TW)

Like Type 40 red, but approved for drinking water.

Type 40 white-red (EPDM beige)

Like Type 40 red, but with light-coloured internal rubber in food-grade.

Type 40 red AF (EPDM AF)

Like Type 40 red, but with abrasion-resistant EPDM rubber compound.

Type 40 green (CSM)

For chemicals, aggressive, chemical wastewater and compressor air containing oil.

Type 40 yellow-grey (NBR)

For oils, fats, gases, diesel fuels, kerosene and crude oil. Not suitable for aromatic and chlorinated hydrocarbons, esters and ketones.

Type 40 white-grey (NBR beige)

Like Type 40 yellow-grey, but with light-coloured internal rubber in food-grade. Not approved for drinking water!

Type 40 grey (CR)

For water, wastewater, swimming pool water, salt water, cooling water with anti-corrosive products containing oil, oil mixtures and compressed air containing oil.

Type 40 red-blue-red (EPDM/aramid)

Like Type 40 red, but with aramid fabric.

Type 40 blue-blue-blue AF (EPDM TW/aramid)

Like Type 40 blue, but with aramid fabric.

Type 40 white-blue-red AF (EPDM beige/aramid)

Like Type 40 white-red, but with aramid fabric.

Type 40 orange-blue-orange AF (EPDM H/aramid)

Like Type 40 red, but with aramid fabric for temperatures up to +125 °C.

Type 40 red-blue-red AF (EPDM AF/aramid)

Like Type 40 red AF, but with aramid fabric.

Type 40 green-blue-green (CSM/aramid)

Like Type 40 green, but with aramid fabric.

Type 40 yellow-blue-grey (NBR/aramid)

Like Type 40 yellow-grey, but with aramid fabric.

Type 40 white-blue-grey (NBR white/aramid)

Like Type 40 white-grey, but with aramid fabric.

Type 40 grey-blue-grey (CR/aramid)

Like Type 40 grey, but with aramid fabric.

Type 40 lilac-blue-lilac (FPM/aramid)

For flue gas desulphurisation systems and bio-diesel. High chemical resistance to benzene, xylene, toluene, aromatic, chlorinated hydrocarbons, mineral acids and fuels with an aromatic content of more than 50 %. Temperatures of up to +180 °C.

Type 40 silicone (silicone/glass fabric or aramid)

Suitable for hot air, acetic acid. Satisfactory resistance to aliphatic engine and gear oils. Also available in foodstuff quality. Excellent resistance to ageing, UV, ozone and weather. Very good radiation resistance. Not for use with steam above 120 °C. No resistance to fuels.

Note!

Detailed material descriptions on pages 5 - 7.

Important information

For aggressive media, please see the resistance table (can be requested separately).
The bellow should not be painted or insulated. Please refer to the installation instructions.
++++ We will be happy to send you further information on the individual types and designs. +++++



WILLBRANDT Rubber Expansion Joint Type 40

Vacuum resistance

Type 40 is a rubber expansion joint that is only vacuum-resistant to a small degree, so a suitable vacuum supporting ring should be used on underpressure.

Standard material: 1.4571

An alternative design with a vulcanised vacuum supporting ring is also available. Please note that greater stiffness rates must be taken into account and that the axial and lateral movement will be reduced.

Further information on vacuum supporting spirals/rings can be found on page 93 of the Technical Appendix.



Expansion joint with supporting ring

Supporting ring versions



Supporting ring with baffle

DN 200 - DN 350



Supporting ring with lock/double lock

DN 200 - DN 450 / DN 500 - DN 5000

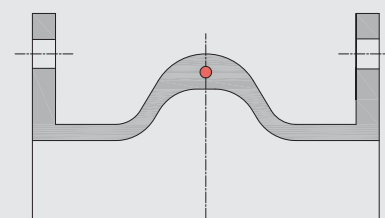

Vulcanised supporting ring (example)

Please take the limited movement into account.

Flange versions

Type 40 is produced with pressure-resistant solid rubber flanges. In order to ensure a tight connection to the pipe/fan, the counter flange should be flat and have no seal. If this is not possible, the expansion joint flange can be produced with a negative recess (see Version 2) in order to accommodate the raised face of the counter flange and ensure a flat connection.

Alternatively, spacer rings can be used (Version 3).

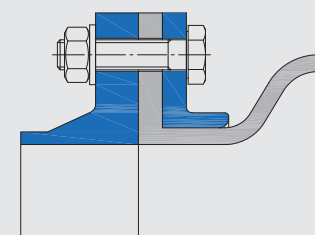

Version 1

Standard version

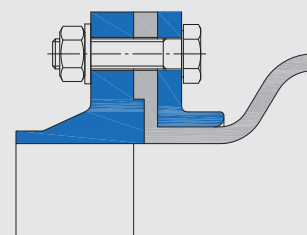

Version 2

with recess compensation

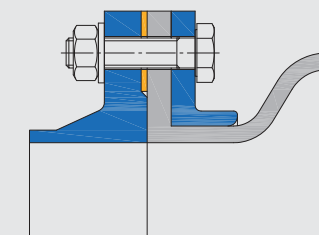

Version 3

with recess spacer ring

Basic forms

There is an extensive package of forms with various corrugation profiles available for Type 40. The following basic forms are available:

DN 200	DN 500	DN 850	DN 1150	DN 1450	DN 1900	DN 2300	DN 2800	DN 3200	DN 4000
DN 250	DN 550	DN 900	DN 1200	DN 1500	DN 1950	DN 2400	DN 2850	DN 3300	DN 4200
DN 300	DN 600	DN 950	DN 1250	DN 1600	DN 2000	DN 2500	DN 2900	DN 3400	DN 4500
DN 350	DN 650	DN 1000	DN 1300	DN 1650	DN 2100	DN 2550	DN 3000	DN 3450	DN 4600
DN 400	DN 700	DN 1050	DN 1350	DN 1700	DN 2200	DN 2600	DN 3100	DN 3600	DN 4800
DN 450	DN 800	DN 1100	DN 1400	DN 1800	DN 2250	DN 2700	DN 3150	DN 3800	DN 5000

WILLBRANDT Rubber Expansion Joint Type 40

Design A - without tie rods

Can be used for movement absorption in any direction (for combined movements, see the movement diagram in the technical appendix), noise and vibration insulation.

The expansion joint's reaction force must be absorbed via suitable piping (see fitting instructions in the appendix).

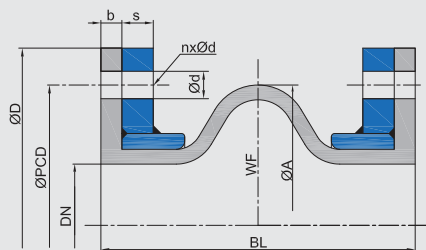

Dimensions for Design A

DN	Length BL*1	ØA*2	Bellows		Flange PN 10*4					Movement absorption*5				Weight kg
			b	WF*3	ØD	ØPCD	Ød	n	s	axial + mm	axial - mm	lateral ± mm	angular ± ∠°	
200	250	280	10	53066	340	295	22	8	20	20	40	26	11.3	19.0
250	250	330	10	75439	395	350	22	12	20	20	40	26	9.1	22.5
300	250	384	10	104009	445	400	22	12	20	20	40	28	7.6	25.0
350	250	432	10	133249	505	460	22	16	20	20	44	27	6.5	31.5
400	250	484	10	169007	565	515	26	16	20	20	44	27	5.7	39.5
450	250	532	10	197823	615	565	26	20	28	20	44	27	5.1	51.0
500	250	585	10	241800	670	620	26	20	28	20	44	27	4.6	57.5
600	250	685	10	336785	780	725	30	20	28	20	44	27	3.8	72.5
700	250	786	10	448656	895	840	30	24	28	20	44	26	3.3	88.5
800	300	917	13	617614	1015	950	33	24	28	31	53	34	4.4	115.0
900	300	1017	13	764723	1115	1050	33	28	28	31	53	33	3.9	128.0
1000	300	1117	13	927532	1230	1160	36	28	28	31	53	33	3.5	146.0
1100	300	1217	13	1106041	1345	1270	36	32	28	31	53	33	3.2	168.0
1200	300	1317	13	1300250	1455	1380	39	32	28	41	43	32	3.9	196.0
1300	300	1417	13	1510159	1565	1485	42	32	28	31	53	32	2.7	219.0
1400	300	1517	13	1735768	1675	1590	42	36	28	31	53	31	2.5	241.0
1500	300	1617	13	1977077	1795	1705	48	36	28	31	53	31	2.4	261.0
1600	300	1717	13	2234086	1915	1820	48	40	28	31	53	31	2.2	291.0
1700	300	1817	13	2478817	2015	1920	48	44	33	31	53	30	2.1	380.0
1800	300	1917	13	2765656	2115	2020	48	44	33	31	53	30	2.0	401.0
1900	300	2017	13	3068195	2220	2125	48	48	33	31	53	29	1.9	428.0
2000	300	2117	13	3386434	2325	2230	48	48	33	31	53	29	1.8	455.0
2100	350	2255	15	3851387	2440	2335	56	48	33	43	69	38	2.3	505.0
2200	350	2355	15	4206992	2550	2440	56	52	33	43	69	37	2.2	539.0
2400	350	2555	15	4965302	2760	2650	56	56	33	43	69	36	2.1	600.0
2500	350	2655	15	5368007	2860	2750	56	56	33	43	69	36	2.0	624.0
2600	350	2755	15	5786412	2960	2850	56	60	33	43	69	35	1.9	646.0
2800	350	2955	15	6670322	3180	3070	56	64	33	43	69	34	1.8	726.0
3000	350	3155	15	7617032	3405	3290	62	68	33	43	69	33	1.6	807.0

*1 Overall lengths available from 150 mm to 500 mm.

*2 Outer diameter of corrugation

*3 WF = effective area

*4 Other standards/dimensions possible.

*5 Movement absorption be increased by changing the the corrugation and overall length.

- Maximum size: DN 5000.

- Movement absorption is for a bellows design with 6 bar operating pressure.

Important information

Please note the appropriate fixed point constructions and plain bearings in your piping system, as well as the tolerances as per the FSA Handbook (see technical appendix on p. 118)!

For more information please refer to our installation instructions in the technical appendix.

++++ We will be happy to send you further information on the individual types and designs. +++++

WILLBRANDT Rubber Expansion Joint Type 40

Other designs

Design E - with tie rods

For absorbing the expansion joint's reaction force in the direction of expansion while also absorbing great lateral movement.

The use of PTFE-coated spherical washers and conical sockets reduces the frictional force considerably during lateral movement. Can be used for vibration insulation and absorbing lateral movement.

Note: The number of tie rods is calculated corresponding to the available design data.

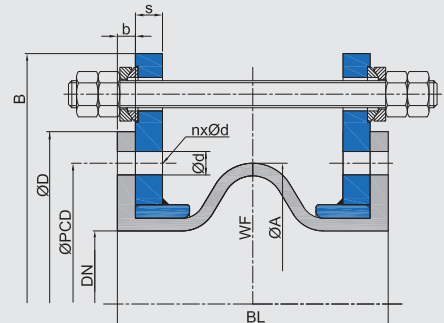

Design M - with tie rods/thrust limiters

For absorbing the expansion joint's reaction force in the direction of expansion while also absorbing high lateral movement and preventing the bellow from strong compression. The use of PTFE-coated spherical washers and conical sockets reduces the frictional force considerably during lateral movement. Can be used for vibration insulation and absorbing lateral movement.

Note: The number of tie rods is calculated corresponding to the available design data.

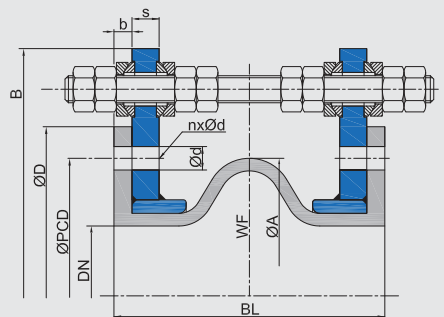

Design F - with hinge

For absorbing angular movement in a single plane while guiding pipes. The hinge absorb the reaction forces so that the fixed point only needs to absorb the adjusting movement.

Usually two hinge expansion joints are fitted with an intermediate pipe to achieve a high level of lateral movement (see the example in the technical appendix).

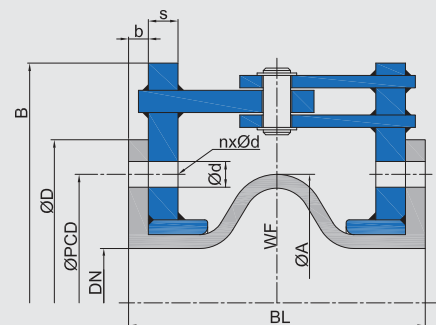

Multi-corrugated bellow designs

Different corrugation geometries and bellow forms (single and multi-corrugated) are available, in order to absorb high axial, lateral and angular movement.

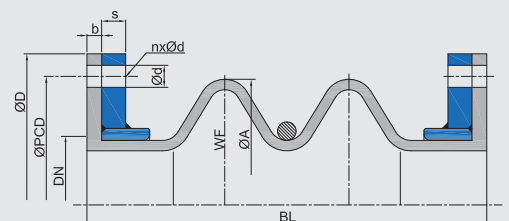

Example - double corrugation, Design A - without tie rods

Important information

Please note the appropriate fixed point constructions and plain bearings in your piping system!
You can find information on this in our installation instructions.

For information on the tie rods, please refer to the technical appendix (p. 89 - 92)!

++++ We will be happy to send you further information on the individual types and designs. +++++

WILLBRANDT Rubber Expansion Joint Type 40

Axial stiffness rates* (single-corrugation)

DN	Length BL mm	Stiffness rates (averages value from full way)									
		0 bar N/mm	1 bar N/mm	1.5 bar N/mm	2.5 bar N/mm	3 bar N/mm	4 bar N/mm	5 bar N/mm	6 bar N/mm	10 bar N/mm	16 bar N/mm
200	200	45	79	83	90	108	144	180	216	360	576
250	200	51	88	95	107	127	166	206	246	405	645
300	200	56	98	105	118	139	180	225	269	454	727
350	200	66	117	124	138	164	216	266	317	541	866
400	250	40	70	75	83	99	131	161	190	322	513
450	250	48	85	91	102	119	152	193	235	389	626
500	250	55	99	105	118	135	171	218	265	457	743
600	250	68	119	125	136	163	218	272	326	544	870
700	250	70	121	130	147	174	228	283	338	557	886
750	250	72	126	134	151	178	232	289	346	583	935
800	250	73	129	137	153	182	239	295	350	599	958
850	250	80	141	149	166	198	262	321	380	644	1026
900	300	95	169	180	202	235	300	383	466	770	1239
1000	300	136	245	260	291	335	422	539	656	1129	1836
1050	350	132	251	264	290	352	475	592	710	1171	1867
1100	350	173	328	345	380	461	622	775	929	1534	2445
1200	350	188	360	381	422	511	688	845	1002	1677	2666
1300	350	204	386	405	443	546	751	924	1096	1827	2902
1400	350	220	415	436	477	588	809	995	1180	1967	3126
1500	350	236	455	484	542	652	871	1083	1295	2120	3368
1600	350	310	597	626	685	836	1138	1403	1668	2821	4504
1700	350	374	721	754	818	1018	1416	1726	2036	3438	5459
1800	350	452	873	912	990	1231	1714	2089	2464	4160	6606
2000	350	690	1339	1408	1546	1868	2512	3171	3830	6314	10115
2100	350	791	1523	1609	1780	2134	2841	3636	4431	7288	11735
2200	350	910	1747	1841	2029	2475	3367	4168	4969	8099	12831
2400	350	1050	1995	2118	2363	2846	3812	4751	5691	9450	15089
2500	400	1210	2142	2275	2541	3013	3957	4882	5808	9922	15887
2600	400	1290	2270	2408	2683	3199	4231	5179	6128	10385	16538
2800	400	1420	2528	2693	3025	3512	4487	5723	6958	11502	18517

Lateral stiffness rates* (single-corrugation)

Warning: Deviations (+/-25%) in the stiffness rates may occur due to use of different materials and manufacturing processes.

DN	Length BL mm	Stiffness rates (averages value from full way)									
		0 bar N/mm	1 bar N/mm	1.5 bar N/mm	2.5 bar N/mm	3 bar N/mm	4 bar N/mm	5 bar N/mm	6 bar N/mm	10 bar N/mm	16 bar N/mm
200	200	200	330	342	366	387	428	484	540	616	804
250	200	220	370	382	407	430	475	540	605	686	898
300	200	250	425	440	470	495	545	620	695	783	1020
350	200	280	482	497	529	556	610	696	781	882	1154
400	250	180	315	326	347	365	400	456	513	576	752
450	250	190	338	349	371	387	420	478	536	604	789
500	250	200	330	342	366	387	428	484	540	616	804
600	250	235	388	402	430	454	503	569	635	724	945
700	250	310	521	538	574	606	670	761	853	967	1265
750	250	310	527	546	583	614	676	769	862	970	1265
800	250	340	585	604	643	675	741	845	949	1071	1401
850	250	340	595	615	656	689	755	862	969	1088	1421
900	300	360	641	661	702	733	796	905	1015	1145	1494
1000	300	380	673	698	749	818	956	1020	1083	1216	1539
1050	350	390	605	628	675	746	889	971	1053	1201	1513
1100	350	395	612	636	683	756	901	984	1067	1217	1533
1200	350	440	724	744	783	864	1025	1111	1197	1390	1756
1300	350	460	724	763	842	923	1086	1180	1274	1463	1840
1400	350	480	724	775	878	963	1133	1231	1330	1526	1920
1500	350	530	885	924	1002	1088	1261	1370	1479	1707	2152
1600	350	645	1109	1152	1238	1342	1548	1683	1819	2090	2632
1700	350	710	1299	1330	1392	1508	1740	1885	2031	2308	2876
1800	350	445	814	834	872	945	1090	1181	1273	1446	1802
2000	350	890	1682	1727	1816	1952	2225	2394	2563	2919	3613
2100	350	886	1692	1745	1852	2002	2304	2450	2596	2835	3367
2200	350	1050	2016	2086	2226	2464	2940	3045	3150	3465	3990
2400	350	1360	2638	2802	3128	3400	3944	4114	4284	4529	5114
2500	400	1680	2856	2957	3158	3326	3662	4166	4670	5258	6854
2600	400	2035	3500	3616	3846	4043	4436	5057	5678	6410	8384
2800	400	2760	4830	4996	5327	5594	6127	6997	7866	8832	11537

* Example values, depending on bellows structure

WILLBRANDT Rubber Expansion Joint Type 40

Angular stiffness torque* (single-corrugation)

DN	Length BL mm	Stiffness torque (averages value from full way)									
		0 bar Nm/°	1 bar Nm/°	1.5 bar Nm/°	2.5 bar Nm/°	3 bar Nm/°	4 bar Nm/°	5 bar Nm/°	6 bar Nm/°	10 bar Nm/°	16 bar Nm/°
200	200	6	10	11	12	14	18	23	28	46	74
250	200	10	16	18	20	24	31	38	46	76	120
300	200	15	25	27	30	36	47	58	70	117	188
350	200	22	39	42	47	55	73	90	107	183	293
400	250	17	30	32	36	43	57	69	82	139	221
450	250	26	45	48	54	63	81	103	125	207	333
500	250	36	64	68	76	88	110	141	172	296	481
600	250	62	108	113	123	148	198	247	296	494	790
700	250	85	147	157	179	211	276	343	410	675	1074
750	250	99	174	186	209	246	320	399	478	805	1290
800	250	118	209	222	248	294	386	476	567	968	1550
850	250	145	255	270	301	359	475	582	688	1166	1857
900	300	191	341	363	408	473	605	771	938	1551	2496
1000	300	334	601	639	715	822	1036	1323	1610	2773	4510
1050	350	355	675	710	781	947	1279	1595	1911	3154	5029
1100	350	508	965	1016	1117	1354	1828	2281	2733	4510	7192
1200	350	654	1248	1320	1464	1771	2386	2932	3477	5817	9249
1300	350	825	1559	1636	1790	2205	3036	3733	4430	7383	11730
1400	350	1024	1935	2030	2221	2737	3767	4632	5497	9162	14557
1500	350	1252	2416	2571	2880	3464	4633	5759	6886	11269	17905
1600	350	1866	3592	3769	4124	5032	6849	8444	10040	16981	27114
1700	350	2528	4880	5099	5537	6885	9582	11681	13779	23260	36938
1800	350	3417	6594	6890	7483	9305	12950	15785	18621	31434	49919
2000	350	6395	12406	13046	14325	17309	23277	29385	35492	58513	93749
2100	350	8062	15520	16394	18141	21742	28944	37047	45150	74256	119567
2200	350	10150	19488	20537	22635	27608	37556	46488	55420	90336	143117
2400	350	13875	26363	27982	31219	37602	50367	62786	75204	124878	199388
2500	400	17315	30648	32553	36362	43116	56622	69868	83114	141987	227352
2600	400	19930	35077	37203	41455	49427	65371	80019	94668	160437	255504
2800	400	25360	45141	48100	54017	62724	80138	102202	124265	205418	330698

* Example values, depending on bellows structure

Warning: Deviations (+/-25 %) in the stiffness torque may occur due to use of different materials and manufacturing processes.

